

# TAJFUN S



## PL

Oprawa TAJFUN to nowoczesny model przemysłowej oprawy oświetleniowej. Bardzo wysoka moc pozwala na efektywne oświetlenie wysokich pomieszczeń w przemyśle oraz strefach magazynowania. Doskonale nadaje się również jako oświetlenie obiektów sportowych. Oprawa posiada wysokiej klasy cichy wentylator, który wspomaga bezawaryjną pracę urządzenia. Wyróżnia się wysoką skutecznością świetlną oraz wąskim kątem rozsyłu.

## EN

TAJFUN is a modern model of an industrial fixture. Very high power allows for efficient lighting of high rooms in industry and storage areas. It is also ideal as lighting for sports facilities. The fixture has a high-quality silent fan that assists in trouble-free operation of the device. It is distinguished by high light efficiency and a narrow beam angle.

## DE

TAJFUN ist ein modernes Modell einer industriellen Leuchte. Sehr hohe Leistung für effiziente Beleuchtung. Es ist auch ideal für die Beleuchtung von Sportanlagen. Das Gerät verfügt über einen hochwertigen leisen Lüfter, der den störungsfreien Betrieb des Geräts unterstützt. Es zeichnet sich durch hohe Lichteffizienz und einen engen Abstrahlwinkel aus.

## OPCJE DO WYBORU / OPTIONS / OPTIONSWAHL MÖGLICH:



DS



4000 K

inna/different/andere\*



55°

85°

75°



DALI



czarny/black/schwarz

inny/different/andere\*

DS - dyfuzyjna szyba hartowana/ diffusive tempered glass / Scheibe aus diffusum gehärtetem Glas

\*Opcje dostępne na zamówienie po konsultacji z działem handlowym. / Options available on request, following consultation with the sales department. / Andere Optionen auf Bestellung nach der Beratung mit der Handelsabteilung erhältlich.

## PL

### PARAMETRY TECHNICZNE

Sposób montażu: zwieszany  
Obudowa: blacha stalowa malowana proszkowo  
Napięcie zasilania: 220-240 V / 50 Hz  
Współczynnik mocy (PF): 0,99  
Klasa ochronności: I  
Wskaźnik oddawania barw CRI(Ra): 85  
Stopień ochrony: IK08  
Stopień szczelności: IP66  
Stopień szczelności przyłącza: IP20 /IP68  
Temperatura otoczenia: od -25°C do +45°C  
Wilgotność otoczenia: 20-80%  
Trwałość (L70B70): 100 000 h

ZASTOSOWANIE: magazyny, hale przemysłowe

## EN

### TECHNICAL PARAMETERS

Mounting: suspended  
Body: sheet steel powder-coated  
Power Supply: 220-240 V / 50 Hz  
Power factor (PF): 0,99  
Protection class: I  
Color rendering index CRI(Ra): 85  
Protection marking: IK08  
Protection marking: IP66  
Protection marking of connection: IP20 /IP68  
Ambient temperature: from -25°C to +45°C  
Ambient humidity: 20-80%  
Lifetime (L70B70): 100 000 h

APPLICATION: warehouses, industrial halls

## DE

### TECHNISCHE DATEN

Montageart: Pendelleuchten  
Gehäuse: pulverlackiert Stahlblech  
Speisespannung: 220-240 V / 50 Hz  
Leistungsfaktor (PF): 0,99  
Schutzklasse: I  
Farbwiedergabe Faktor CRI(Ra): 85  
Schutzklasse: IK08  
Schutzklasse: IP66  
Schutzklasse Anschluss: IP20 /IP68  
Umgebungstemperatur: von -25°C bis +45°C  
Umgebungsluftfeuchtigkeit: 20-80%  
Lebensdauer (L70B70): 100 000 h

EINSATZBEREICH: Lagerräume, Industriehallen

Deklarowana trwałość dotyczy opraw pracujących w temperaturze otoczenia 45 °C przy zapewnionych optymalnych warunkach wentylacji. / The declared lifetime applies to fixtures operating at an ambient temperature of 25°C with ensured optimal ventilation conditions. / Die erklärte Lebensdauer bezieht sich auf Leuchten, die bei einer Raumtemperatur von 25°C und optimalen Lüftungsbedingungen arbeiten.

PRODUKTY / PRODUCTS / PRODUKTE:



[W]

[K]

[°]

[lm]

[lm/W]

Typ: DALI / Type: DALI / Art: DALI

TAJFUN-S	4000K/DS/55/DA	180	4000	DS	55	20000	111	DALI
TAJFUN-S	4000K/DS/75/DA	180	4000	DS	75	20000	111	DALI
TAJFUN-S	4000K/DS/85/DA	180	4000	DS	85	20000	111	DALI

Całkowity strumień świetlny oprawy zmierzony za kloszem przy temp. otoczenia 25°C. Tolerancja strumienia świetlnego +/- 10%. Pomiar fotometryczny został wykonany zgodnie z wymaganiami normy PN-EN13032. / The total luminous flux of the luminaire measured diffuser 25°C. Luminous flux tolerance +/- 10%. Photometric measurement were examined in accordance with the PN-EN13032 system. / Gesamtlichtstrom der Leuchte, gemessen hinter der Abdeckung 25°C. Lichtstrom-Toleranz +/- 10%. Photometrische Messungen wurden nach PN-EN13032 Norm geprüft.

ELEMENTY DODATKOWE / ADDITIONAL ELEMENTS / PRODUKTE:



PL

EN

DE

E05-975	Złącze IP68 DALI	Connector IP68 DALI	Verbinder IP68 DALI
---------	------------------	---------------------	---------------------

FOTOMETRIA / PHOTOMETRY / PHOTOMETRIE:

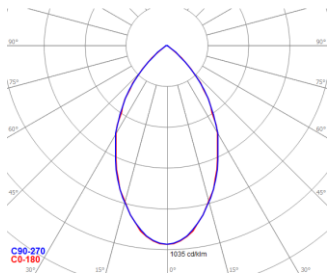

TAJFUN-S-DS-55\_180W\_4000K

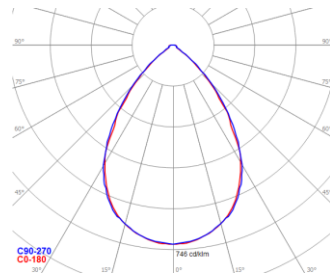

TAJFUN-S-DS-75\_180W\_4000K

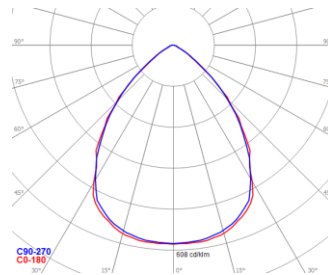

TAJFUN-S-DS-85\_180W\_4000K

WYMIARY / DIMENSIONS / MASSE:





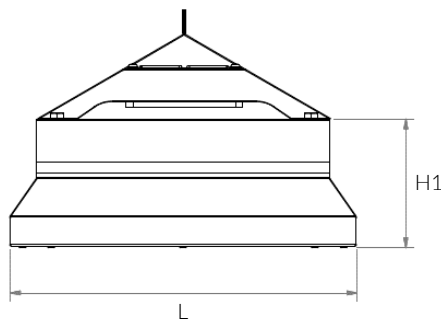
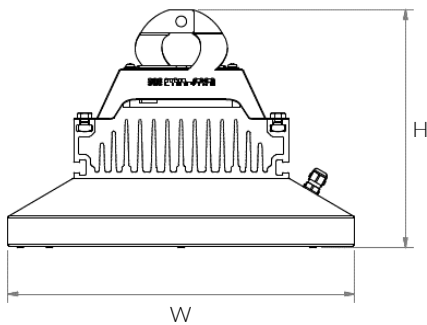

















CODE	L [mm]	W [mm]	H [mm]	H1 [mm]	[kg]
TAJFUN-S	355	355	243	129	7,3



W związku z ciągłym rozwojem produktów zastrzegamy sobie prawo do wprowadzania zmian konstrukcyjnych w oprawach oraz aktualizowania parametrów.  
Due to continuous product development, we reserve the right to introduce structural changes in the fixtures and to update their parameters.  
Aufgrund der ständigen Produktentwicklung behalten wir uns das Recht vor, technische Änderungen und Aktualisierung von Parametern an Leuchten vorzunehmen.

Data aktualizacji / Revision Date / Datum der letzten Aktualisierung: 07.12.2017

LEGENDA / LEGENDA / LEGENDA:

	Deklaracja zgodności Declaration of conformity EG-Konformitätserklärung		Klasa ochronności I Protection class I Schutzklasse I		Napięcie zasilania Power supply Speisespannung
	Źródło światła LED LED source LED Quelle		Klasa efektywności energetycznej Energy efficiency class Energieeffizienzklasse		Dyrektywa RoHS The RoHS Directive RoHS Richtlinie
	Wymiary montażowe Mounting dimensions Montagemaße		Stopień szczelności IP IP protection marking Schutzklasse IP		Atest higieniczny PZH Hygiene certificate of the NIH Attest von Polnischer Hygieneanstalt
	Kod produktu Code Artikelnummer		Rodzaj klosza Cover Abdeckung		Moc oprawy Luminaire power Leistung der Leuchte
	Kąt rozsyłu światłości Light distribution angle Winkel der Lichtverteilung		Wymiary Dimensions Masse		Temperatura barwowa Color temperature Farbtemperatur
	Strumień świetlny Luminous flux Lichtstrom		Skuteczność świetlna Luminous efficiency Lichtausbeute der Leuchte		System sterowania DALI DALI control system Steuersystem DALI
	Kolor oprawy Luminaire color Leuchte Farbe		Waga Weight Gewicht		