



CARACTERÍSTICAS GENERALES:

- Oring FET opcional
- Alto aislamiento entrada-salida
- Tensión de salida ajustable
- Detección remota
- Inhibición remota
- LED entrada y salida correcta
- Alarma de fallo de salida
- Protec. inversión polaridad de entrada
- Versión Ferroviaria EN50155
- Fuego y humo: Aprobado EN45545-2

GENERAL FEATURES:

- Oring FET option
- High input-output isolation
- Adjustable output voltage
- Remote sensing
- Remote inhibit
- Input & Output OK LEDs
- Output failure alarm
- Input reverse polarity protection
- Railway version EN50155
- Fire and smoke: EN45545-2 approved

	24 Vin 14.4 ... 30V 16.8 ... 30V (1)	36Vin 21,6V ... 45V 25,2V ... 45V ⁽¹⁾	48 Vin 28.8 ... 60V 33.6 ... 60V (1)	72 Vin 43.2 ... 90V 50.4 ... 90V (1)	110 Vin 66 ... 144V 77 ... 144V(1)
24Vout	CRS-500-6455 500W 88%	CRS-500-6467 500W 88%	CRS-500-6458 500W 91%	CRS-500-6461 500W 91%	CRS-500-6464 500W 91%
48Vout	CRS-500-6456 500W 89%	CRS-500-6468 500W 89%	CRS-500-6459 500W 91%	CRS-500-6462 500W 91%	CRS-500-6465 500W 92%
110Vout	CRS-500-6457 500W 90%	-	-	-	-

ENTRADA	INPUT	
Margen de tensión de entrada	Input voltage range	See table
Rizado máximo de entrada	Maximum input ripple	5% Vrms, 15% Vpp
Rendimiento típico a plena carga	Typical efficiency at full load	See table
SALIDA	OUTPUT	
Margen de ajuste de tensión	Voltage adjust range	-10% ... 0% Vout nom
Margen de ajuste de tensión (1)	Voltage adjust range (1)	-10% ... +15% Vout nom
Regulación de línea	Line regulation	< 0,2 %
Regulación de carga	Load regulation	< 0,2 %, 2,5 % for ORing FET option
Rizado	Ripple	< 50 mVpp (< 100mV for 72 / 110 Vout)
Ruido (BW 20MHz)	Noise (BW 20MHz)	< 100 mVpp (< 500mV for 72 / 110 Vout)
Protección sobretensiones máx.	Max. overvoltage protection	< 140% Vout nom
Detección remota máxima	Max. remote sense	0,3V / pole
Potencia total de salida (Po):	Total Output power (Po):	Ver tabla / See table
AMBIENTE	AMBIENT	
Temperatura de almacenamiento	Storage temperature	-40°C ... 85°C
Temperatura de funcionamiento I _o : 100%	Operating temperature range I _o : 100%	-25°C ... 55°C (-40°C ... 55°C, see note-1)
Temperatura de funcionamiento I _o : 63%	Operating temperature range I _o : 63%	-25°C ... 70°C (-40°C ... 70°C, see note-1)
Refrigeración	Cooling	Natural convection
Humedad relativa	Relative humidity	95% with no condensation
MTBF	MTBF	400.000h @ 40°C according to IEC61709
CEM	EMC	
Emisión según norma/s	Emission according to norm/s	EN61000-6-3 (EN50121-3-2)
Inmunidad según norma/s	Immunity according to norm/s	EN61000-6-2 (EN50121-3-2)
SEGURIDAD	SAFETY	
Seguridad según norma/s	Safety according to norm/s	EN60950
Rigidez dieléctrica Entrada/Salida	Dielectric strength Input/Output	3000Vac, 4200Vdc 1min.
Rigidez dieléctrica Entrada/Tierra	Dielectric strength Input/Ground	1500Vac, 2100Vdc 1min.
Rigidez dieléctrica Salida /Tierra	Dielectric strength Output/Ground	1500Vac, 2100Vdc 1min.
Fuego y humo	Fire and smoke	EN45545-2 (Levels HL1 and HL2)
MECÁNICA	MECHANICAL	
Peso	Weight	1800g
CONTROL	CONTROL	
Margen de entrada de inhibición remota	Remote inhibit input range	16.8 ... 143 Vdc
Contactos de alarma	Alarm contacts	1A @ 24Vdc, 0.3A @ 150Vdc, 1A @ 125Vac
Local: Entrada OK, Salida OK	Local: Input OK, Output OK	Green LEDs
PROTECCIONES	PROTECTIONS	
Contra sobrecargas y cortocircuitos	Against overloads and short-circuits	Current limiting
Contra sobretensión de salida	Against output over-voltages	Shutdown (reset by input switch off)
Contra inversión de polaridad	Against reverse input voltage	Input fuse (Active protection with option H)
Contra Sub-tensión de entrada	Against input under-voltage	Under-voltage lock-out
Contra Sobre-corrientes de entrada	Against Input over-currents	Input fuse

Note-1: The unit can start up and work at an ambient temperature of -40°C with the following restrictions:

1) Do not actuate over the connectors below -25°C. 2) The output ripple can rise up to 150mVpp at -40°C

Diagrama de bloques / Blocks Diagram

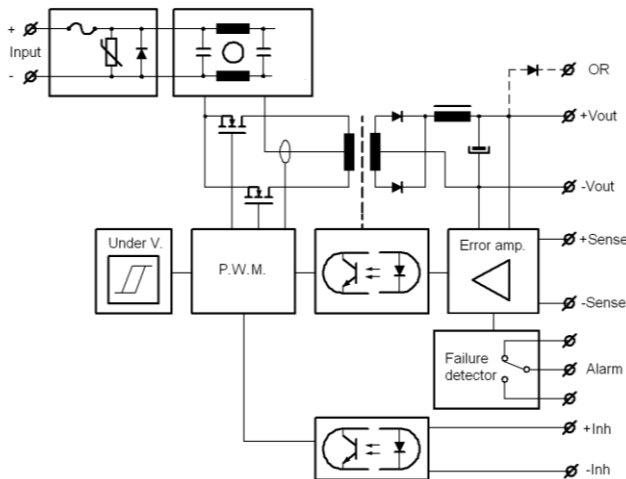

Característica típica de salida / Typical output characteristic

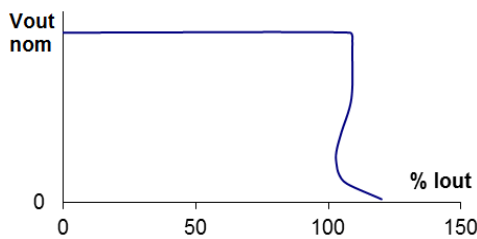

Power connections (input and output)	
Spring clamp terminals up to 16mm ²	
Signals connector	
1	+ Inhibit
2	- Inhibit
3	- Remote sense
4	+ Remote sense
5	Alarm relay NC (closed when alarm)
6	Alarm relay Common
7	Alarm relay NO (open when alarm)

Dimensiones / Dimensions

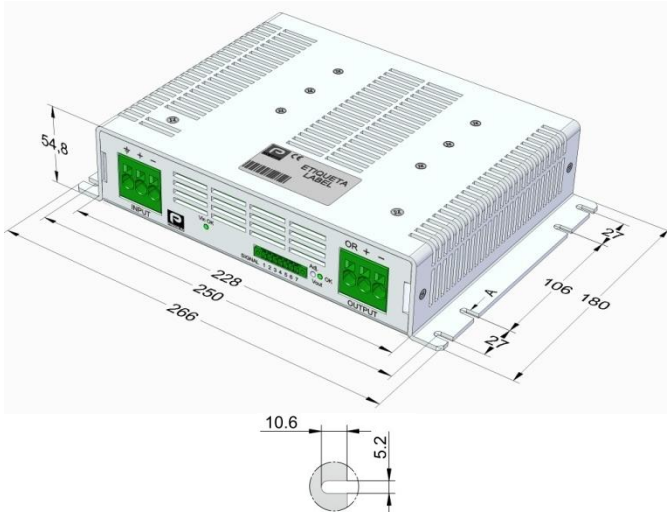

DESCRIPCIÓN

La serie CRS-500 está constituida por convertidores de corriente continua a corriente continua con aislamiento galvánico entre la entrada y la salida, conmutando a frecuencia fija y empleando la topología de convertidor en contrafase.

Para disponer de la máxima regulación, pueden conectarse a la carga los terminales de detección remota. Esto permite compensar una caída en los cables de potencia hasta 0,3V en cada uno de ellos.

El aparato está protegido contra sobrecargas y cortocircuitos por un circuito limitador de corriente.

También está preparado para soportar una inversión de polaridad de tensión a la entrada, fundiendo el fusible de entrada en caso de conexión errónea.

En caso de subtensión en la entrada el convertidor se inhibe evitando la descarga total de la batería.

DESCRIPTION

The CRS-500 series consists of DC-DC converters with a galvanic isolation between input and output. The converters operate at a fixed switching frequency and use push-pull converter topology.

For maximum regulation, the remote sensing terminals can be connected to the load. This will allow a power cable voltage drop of up to 0.3 V on each cable to be offset.

The device is protected against overloads and short-circuits by means of a current limiting circuit.

The device is also protected against reverse polarity input voltage, and the input fuse blows if an improper connection is made.

When a converter input undervoltage condition occurs, the converter is disabled, thus preventing the battery from becoming totally discharged.

INSTALACIÓN

El producto puede instalarse de varias formas:

- Sobre un chasis mediante los taladros de las escuadras
- En carril DIN añadiendo dos accesorios clip **NP-9135**.
- En subrack de 6U añadiendo el accesorio **NP-9222**

INSTALLATION

The product can be mounted in several ways:

- On a chassis by means of the mounting brackets holes.
- On a DIN rail adding two clip accessories **NP-9135**.
- Into a 6U subrack adding the accessory **NP-9222**

PUESTA EN MARCHA

Efectuar la conexión según la figura. La utilización de la detección remota (sense) no es imprescindible, pero si se requiere hacerla es recomendable utilizar cable coaxial o bien un par trenzado.

PRECAUCIÓN: Si la carga se conecta a las tomas de detección remota (+/-S) faltando la conexión de la salida a dicha carga la función detección remota se puede inutilizar debido a la actuación del fusible interno de protección.

Si se requiere obtener potencias cercanas a la máxima es importante que el montaje favorezca la refrigeración por convención natural y el convertidor esté en posición vertical.

Si se desea conectar varios convertidores en paralelo deberá realizar lo siguiente:

- Ajustar la tensión de salida de todos los convertidores con una diferencia entre ellas lo menor posible.
- Unir las salidas en la carga utilizando cables de sección no mayor que la apropiada, y de igual longitud.
- No utilizar detección remota.

Por motivos de seguridad es necesario:

- Proporcionar al equipo una envolvente de protección conforme a las directivas de seguridad eléctrica del país donde sea instalado.
- Para sustituir el fusible hacerlo por otro del mismo calibre y tipo con el convertidor desconectado de la alimentación eléctrica.

ACCESORIOS / ACCESSORIES

2601-396

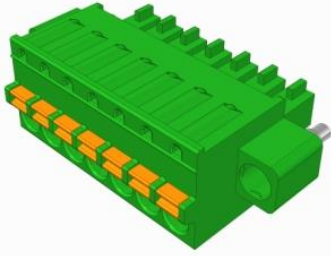

NP-9135

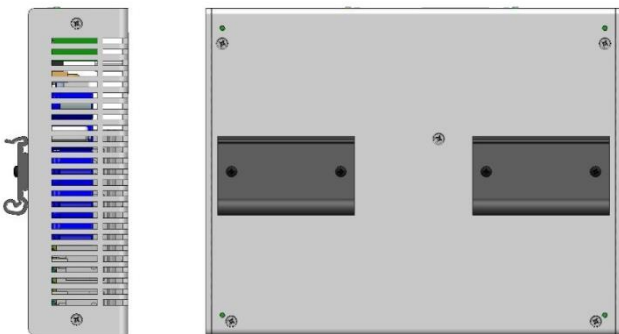

START-UP

Perform connection according to the figure. Use of remote sensing is not mandatory, but if this is required, use of a co-axial or a twisted-pair cable is recommended.

WARNING: If the load is connected to the tabs of remote sensing (+/-S) and the connection from the output to this load is missing the remote sensing function could make unusable due to the acting of the internal fuse of protection.

If power levels close to the maximum output are required, make sure the assembly enhances cooling by natural convection and the unit is placed in vertical position.

If several converters need to be connected in parallel, do the following:

- Set the output voltage for all converters featuring a mutual difference as small as possible.
- Join the load outputs by using cables with a cross-section no greater than the one required and of equal length.
- Do not use remote sensing.

For safety reasons, the following requirements must be complied with:

- Provide the equipment with a protective enclosure that complies with the electrical safety directives in effect within the country where the equipment is installed.
- Only replace the fuse with another fuse of the same rating and type, and only after disconnecting the converter from DC power.

ACCESORIOS	CÓDIGO PEDIDO
Conector hembra de señales	2601-395
CLIP CARRIL DIN	2 x NP-9135
Pletinas guía para subrack	1 x NP-9222
Kit bandeja para rack 19" de 2U	NP-9354

ACCESSORIES	ORDERING CODE
Signals female connector	2601-395
DIN RAIL CLIP	2 x NP-9135
Subrack guiding plates	1 x NP-9222
2U 19" rackmount tray kit	NP-9354

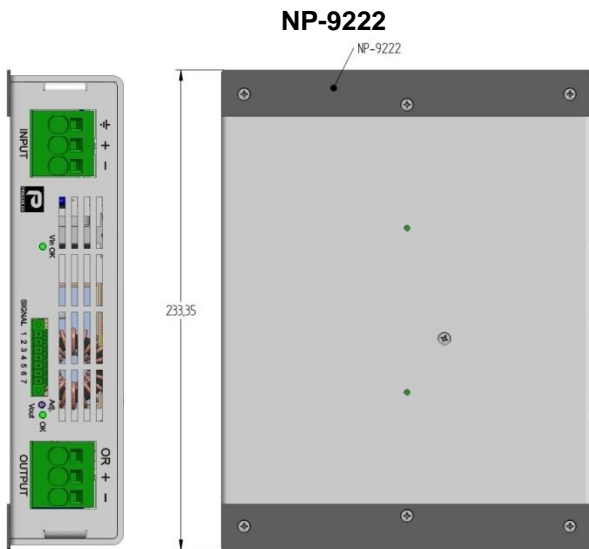

OPCIONES	CÓDIGO PEDIDO
Versión industrial básica	CRS-500-64XX-B
Versión ferroviaria básica	CRS-500-64XX-T
<ul style="list-style-type: none"> • Tiempo de mantenimiento de 10ms (Nota-1) • Protección activa contra inversión de polaridad de entrada • Limitación activa de corriente de arranque: $I(\text{arranque}) < 3 \cdot I(\text{entrada nom.})$ 	CRS-500-64XX-H
Oring FET para redundancia Incluye reparto de corriente pasivo por caída de tensión $< 2.5\%$	CRS-500-64XX-O
Caja sin escuadras de fijación para subrack de 6U o carril DIN	CRS-500-64XX-P

Nota-1

Tiempo de mantenimiento: 10ms a 500W y V_{in} nom para todos los modelos excepto para **6455** y **6456** a 440W y V_{in} nom

Ejemplos de pedido:

CRS-500-6458-BO

- Tensiones entrada/salida: 48V / 24V
- Versión industrial
- Con ORing

CRS-500-6458-THO

- Tensiones entrada/salida: 48V / 24V
- Versión ferroviaria
- Con 10ms de tiempo de mantenimiento...
- Con ORing

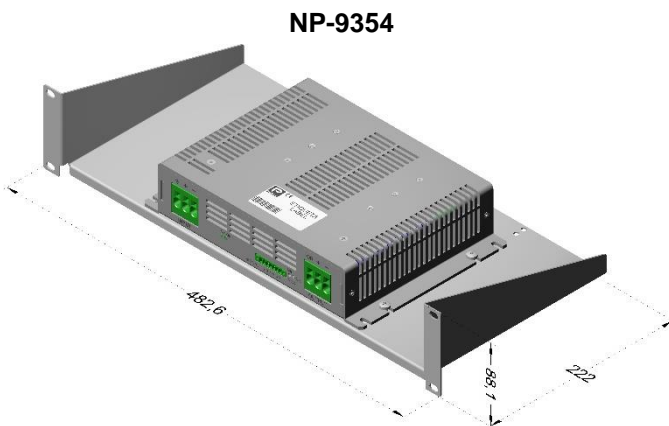

OPTIONS	ORDERING CODE
Industrial basic version	CRS-500-64XX-B
Railway basic version	CRS-500-64XX-T
<ul style="list-style-type: none"> • Hold up time 10ms (Note-1) • Active protection against input reverse polarity • Active inrush current limiter: $I(\text{inrush}) < 3 \cdot I(\text{input nominal})$ 	CRS-500-64XX-H
Oring FET for redundancy Includes a passive current sharing by voltage drop $< 2.5\%$	CRS-500-64XX-O
Case without mounting brackets for 6U subrack fitting or DIN rail	CRS-500-64XX-P

Note-1

Hold up time: 10ms at 500W and V_{in} nom for all the models except **6455** and **6556** at 440W and V_{in} nom.

Ordering examples:

CRS-500-6458-BO

- Voltages input/output: 48V / 24V
- Industrial version
- With ORing

CRS-500-6458-THO

- Railway version
- Voltages input/output: 48V / 24V
- With 10ms hold up time...
- With ORing



DECLARACIÓN DE CONFORMIDAD UE



EU DECLARATION OF CONFORMITY

El abajo firmante, en representación de / The undersigned, representing the following:

Fabricante / Manufacturer: PREMIUM, S. A.,

Dirección / Address: C/. Dolors Aleu 19-21, 2º 2ª 08908 L'Hospitalet de Llobregat, SPAIN

declara que el producto / herewith declares that the product:

Tipo / Type: **Convertidor CC/CC / DC/DC converter**

Modelos / Models: **CRS-500-6455 ... 6468**

es conforme con las disposiciones de las siguientes directivas UE:

is in conformity with the provisions of the following EU directive(s):

2014/35/EU	Baja tensión	Low voltage
2014/30/EU	Compatibilidad electromagnética	Electromagnetic compatibility

y se han aplicado las normas y/o especificaciones técnicas siguientes:

and that standards and/or technical specifications referenced overleaf have been applied:

EN 60950: 2005	Seguridad (Equipos de tratamiento de la información)	Safety (Information technology equipment)
EN 61000-6-3: 2007	Norma genérica de emisión	Generic emission standard
EN 61000-6-2: 2005	Norma genérica de inmunidad	Generic Immunity standard
EN 50155: 2007*	Aplicaciones ferroviarias. Equipos electrónicos utilizados sobre material rodante	Railway applications. Electronic equipment used on rolling stock material
EN 50121-3-2: 2016*	Aplicaciones ferroviarias. CEM de material rodante. Aparatos	Railway applications. EMC Rolling stock equipment
EN 50121-4: 2016*	Aplicaciones ferroviarias. CEM Aparatos de señalización y telecomunicación	Railway applications. EMC of the signalling and telecommunications apparatus

* Ver anexo / See annexe

Notas / Notes:

Para el cumplimiento de esta declaración el producto debe usarse sólo para el fin que ha sido concebido, teniendo en cuenta las limitaciones establecidas en el manual de instrucciones o la ficha técnica

For the fulfillment of this declaration the product must be used only for the aim that has been conceived, considering the limitations established in the instructions manual or datasheet.

L'Hospitalet de Llobregat, 18-12-2017

Jordi Gazo

Director Gerente / Managing Director

PREMIUM S.A. is an ISO9001 certified company by **Bureau Veritas**

Valores aplicables para los apartados de la norma EN50155: 2007		Applicable values for the different sections of the norm EN50155: 2007																																																																																																					
4.1.1	Altitud de trabajo Working altitude	Up to 1800m																																																																																																					
4.1.2	Temperatura ambiente Ambient temperature	Class T1 column 2: (-25...55°C) load at 100% Class T2 column 2: (-40...55°C) load at 100% and output ripple <150mVpp Class T3 column 2: (-25...70°C) load at 50% Class TX column 2: (-40...70°C) load at 50% and output ripple <150mVpp																																																																																																					
4.1.3	Choques y vibraciones Shocks and vibrations	According EN61373:2010 Category 1 class B																																																																																																					
4.1.4	Humedad relativa Relative humidity	Up to 95%																																																																																																					
5.1.1.1	Variaciones de la tensión de alimentación Power supply voltage variations	From 0.70 to 1.25 Un continuous From 0.60 to 1.40 Un 0.1s From 1.25 to 1.40 Un 1s without damage																																																																																																					
5.1.1.2	Interrupciones de la tensión de alimentación Power supply interruptions	With option H: Class S2 (10ms); otherwise Class S1 (without interruptions)																																																																																																					
5.1.1.4	Factor de ondulación a la entrada Input ripple factor	Up to 15% of Vin nom																																																																																																					
5.1.3	Conmutación de la alimentación Power supply switching	Class C1 (0.6 Un during 100ms without interruptions)																																																																																																					
5.2	Sobretensiones de alimentación Power supply over-voltages	1.40 Un 1s (impedance 1 ohm)																																																																																																					
5.5	CEM Compatibilidad electromagnética EMC Electromagnetic Compatibility EN50121-3-2:2016 EN50121-4:2016	<table border="1"> <thead> <tr> <th>Test</th> <th>Norm</th> <th>Port</th> <th>Frequency</th> <th>Limits</th> </tr> </thead> <tbody> <tr> <td rowspan="4">Radiated emissions</td> <td rowspan="4">IEC55016</td> <td rowspan="4">Enclosure</td> <td>30MHz...230MHz</td> <td>40dB(µV/m) Qpk at 10m</td> </tr> <tr> <td>230MHz...1GHz</td> <td>47dB(µV/m) Qpk at 10m</td> </tr> <tr> <td>1...3GHz</td> <td>Do not apply</td> </tr> <tr> <td>3...6GHz</td> <td>Internal freq. < 108MHz</td> </tr> <tr> <td rowspan="2">Conducted emissions</td> <td rowspan="2">IEC55016</td> <td rowspan="2">Input</td> <td>150kHz...500kHz</td> <td>99dB(µV) Qpk</td> </tr> <tr> <td>500kHz...30MHz</td> <td>93dB(µV) Qpk</td> </tr> </tbody> </table>	Test	Norm	Port	Frequency	Limits	Radiated emissions	IEC55016	Enclosure	30MHz...230MHz	40dB(µV/m) Qpk at 10m	230MHz...1GHz	47dB(µV/m) Qpk at 10m	1...3GHz	Do not apply	3...6GHz	Internal freq. < 108MHz	Conducted emissions	IEC55016	Input	150kHz...500kHz	99dB(µV) Qpk	500kHz...30MHz	93dB(µV) Qpk	<table border="1"> <thead> <tr> <th>Test</th> <th>Norm</th> <th>Port</th> <th>Severity</th> <th>Conditions</th> <th>P</th> </tr> </thead> <tbody> <tr> <td rowspan="2">Electrostatic discharge</td> <td rowspan="2">IEC61000-4-2</td> <td rowspan="2">Case</td> <td>±8kV</td> <td>Air (isolated parts)</td> <td rowspan="2">B</td> </tr> <tr> <td>±6kV</td> <td>Contact (conductive parts)</td> </tr> <tr> <td rowspan="4">Radiated high-frequency</td> <td rowspan="4">IEC61000-4-3</td> <td rowspan="4">X/Y/Z Axis</td> <td>20V/m</td> <td>0.08...1.0GHz M. 80% 1kHz</td> <td rowspan="4">A</td> </tr> <tr> <td>10V/m</td> <td>1.4...2.1GHz M. 80% 1kHz</td> </tr> <tr> <td>5V/m</td> <td>2.1...2.5GHz M. 80% 1kHz</td> </tr> <tr> <td>3V/m</td> <td>5.1...6Ghz M. 80% 1kHz</td> </tr> <tr> <td rowspan="4">Fast transients</td> <td rowspan="4">IEC61000-4-4</td> <td>Input</td> <td>±2kV</td> <td>Tr/Th: 5/50 ns</td> <td rowspan="4">A</td> </tr> <tr> <td>Output</td> <td>±2kV</td> <td>Tr/Th: 5/50 ns</td> </tr> <tr> <td>Signal</td> <td>±2kV</td> <td>Tr/Th: 5/50 ns</td> </tr> <tr> <td>E</td> <td>±1kV</td> <td>Tr/Th: 5/50 ns</td> </tr> <tr> <td rowspan="2">Surge</td> <td rowspan="2">IEC61000-4-5</td> <td>Input L to L</td> <td>±1kV</td> <td>Tr/Th: 1.2/50µs</td> <td rowspan="2">B</td> </tr> <tr> <td>Input L to E</td> <td>±2kV</td> <td>Tr/Th: 1.2/50µs</td> </tr> <tr> <td rowspan="4">Conducted RF</td> <td rowspan="4">IEC61000-4-6</td> <td>Input</td> <td>10V</td> <td>0.15...80MHz M. 80% 1kHz</td> <td rowspan="4">A</td> </tr> <tr> <td>Output</td> <td>10V</td> <td>0.15...80MHz M. 80% 1kHz</td> </tr> <tr> <td>Signal</td> <td>10V</td> <td>0.15...80MHz M. 80% 1kHz</td> </tr> <tr> <td>E</td> <td>10V</td> <td>0.15...80MHz M. 80% 1kHz</td> </tr> <tr> <td>Magnetic field</td> <td>IEC61000-4-8</td> <td>X/Y/Z Axis</td> <td>300A/m</td> <td>0Hz, 16.7Hz, 50/60Hz</td> <td>A</td> </tr> <tr> <td>Pulse magnetic field</td> <td>IEC61000-4-9</td> <td>X/Y/Z Axis</td> <td>300A/m</td> <td>Tr/Th: 6.4/16µs</td> <td>B</td> </tr> </tbody> </table>	Test	Norm	Port	Severity	Conditions	P	Electrostatic discharge	IEC61000-4-2	Case	±8kV	Air (isolated parts)	B	±6kV	Contact (conductive parts)	Radiated high-frequency	IEC61000-4-3	X/Y/Z Axis	20V/m	0.08...1.0GHz M. 80% 1kHz	A	10V/m	1.4...2.1GHz M. 80% 1kHz	5V/m	2.1...2.5GHz M. 80% 1kHz	3V/m	5.1...6Ghz M. 80% 1kHz	Fast transients	IEC61000-4-4	Input	±2kV	Tr/Th: 5/50 ns	A	Output	±2kV	Tr/Th: 5/50 ns	Signal	±2kV	Tr/Th: 5/50 ns	E	±1kV	Tr/Th: 5/50 ns	Surge	IEC61000-4-5	Input L to L	±1kV	Tr/Th: 1.2/50µs	B	Input L to E	±2kV	Tr/Th: 1.2/50µs	Conducted RF	IEC61000-4-6	Input	10V	0.15...80MHz M. 80% 1kHz	A	Output	10V	0.15...80MHz M. 80% 1kHz	Signal	10V	0.15...80MHz M. 80% 1kHz	E	10V	0.15...80MHz M. 80% 1kHz	Magnetic field	IEC61000-4-8	X/Y/Z Axis	300A/m	0Hz, 16.7Hz, 50/60Hz	A	Pulse magnetic field	IEC61000-4-9	X/Y/Z Axis	300A/m	Tr/Th: 6.4/16µs	B
		Test	Norm	Port	Frequency	Limits																																																																																																	
		Radiated emissions	IEC55016	Enclosure	30MHz...230MHz	40dB(µV/m) Qpk at 10m																																																																																																	
					230MHz...1GHz	47dB(µV/m) Qpk at 10m																																																																																																	
					1...3GHz	Do not apply																																																																																																	
					3...6GHz	Internal freq. < 108MHz																																																																																																	
		Conducted emissions	IEC55016	Input	150kHz...500kHz	99dB(µV) Qpk																																																																																																	
					500kHz...30MHz	93dB(µV) Qpk																																																																																																	
		Test	Norm	Port	Severity	Conditions	P																																																																																																
		Electrostatic discharge	IEC61000-4-2	Case	±8kV	Air (isolated parts)	B																																																																																																
					±6kV	Contact (conductive parts)																																																																																																	
		Radiated high-frequency	IEC61000-4-3	X/Y/Z Axis	20V/m	0.08...1.0GHz M. 80% 1kHz	A																																																																																																
					10V/m	1.4...2.1GHz M. 80% 1kHz																																																																																																	
					5V/m	2.1...2.5GHz M. 80% 1kHz																																																																																																	
3V/m	5.1...6Ghz M. 80% 1kHz																																																																																																						
Fast transients	IEC61000-4-4	Input	±2kV	Tr/Th: 5/50 ns	A																																																																																																		
		Output	±2kV	Tr/Th: 5/50 ns																																																																																																			
		Signal	±2kV	Tr/Th: 5/50 ns																																																																																																			
		E	±1kV	Tr/Th: 5/50 ns																																																																																																			
Surge	IEC61000-4-5	Input L to L	±1kV	Tr/Th: 1.2/50µs	B																																																																																																		
		Input L to E	±2kV	Tr/Th: 1.2/50µs																																																																																																			
Conducted RF	IEC61000-4-6	Input	10V	0.15...80MHz M. 80% 1kHz	A																																																																																																		
		Output	10V	0.15...80MHz M. 80% 1kHz																																																																																																			
		Signal	10V	0.15...80MHz M. 80% 1kHz																																																																																																			
		E	10V	0.15...80MHz M. 80% 1kHz																																																																																																			
Magnetic field	IEC61000-4-8	X/Y/Z Axis	300A/m	0Hz, 16.7Hz, 50/60Hz	A																																																																																																		
Pulse magnetic field	IEC61000-4-9	X/Y/Z Axis	300A/m	Tr/Th: 6.4/16µs	B																																																																																																		
P= Performance criteria, L= Line, E= PE (Protective Earth)																																																																																																							
7.2.6	Protección inversión de polaridad de entrada Input reverse polarity protection	With option H: Active; otherwise by fuse																																																																																																					
9.7	Recubrimiento de protección del PCB PCB protection	PCB conformal coated																																																																																																					
12.2	Lista de ensayos Tests list	1 Visual Inspection 2 Performance test 3 Cooling 4 Dry heat 6 Supply overvoltages 7 Surge, ESD and burst susceptibility 8 RF Interferences 9 Insulation 11 Shocks and vibrations 13 Equipment stress screening: 24h at 40°C and load 100% 14 Low temperature storage	Routine Routine Type Type Type Type Type Routine Type Routine Type																																																																																																				