



#### CARACTERÍSTICAS GENERALES:

- Diseñado según EN50155
- Fuego y humo: Aprobado EN45545-2
- Alto aislamiento entrada-salida
- Dimensiones estándar Eurocard 3U
- Tensión de salida ajustable
- LED tensión de entrada correcta
- LED presencia de tensión de salida
- Inhibición remota.
- Opción: detección remota o alarma

#### GENERAL FEATURES:

- Designed according to EN50155
- Fire and smoke: EN45545-2 approved
- High input-output isolation
- Standard size Eurocard 3U
- Adjustable output voltage
- Input voltage OK LED
- Output voltage presence LED
- Remote inhibit
- Option: remote sensing or alarm

	24Vin 14,4V ... 30V 16,8V ... 30V <sup>(1)</sup>	36Vin 21,6V ... 47V 25,2V ... 47V <sup>(1)</sup>	48Vin 28,8V ... 60V 33,6V ... 60V <sup>(1)</sup>	72Vin 43,2V ... 90V 50,4V ... 90V <sup>(1)</sup>	110Vin 66V ... 144V 77V ... 144V <sup>(1)</sup>
5Vout	CTS-240-6655 180W 80%	CTS-240-6672 180W 80%	CTS-240-6659 180W 80%	CTS-240-6663 180W 81%	CTS-240-6667 180W 81%
12Vout	CTS-240-6656 240W 83%	CTS-240-6673 240W 83%	CTS-240-6660 240W 84%	CTS-240-6664 240W 88%	CTS-240-6668 240W 86%
24Vout	CTS-240-6657 240W 87%	CTS-240-6674 280W 87%	CTS-240-6661 280W 88%	CTS-240-6665 280W 90%	CTS-240-6669 280W 91%
48Vout	CTS-240-6658 240W 88%	CTS-240-6675 280W 88%	CTS-240-6662 280W 89%	CTS-240-6671 280W 90%	CTS-240-6670 280W 92%

ENTRADA	INPUT	
Margen de tensión de entrada	Input voltage range	See table
Paro por sub-tensión de entrada	Input undervoltage shutdown	55% to 60% Vi nom
Rizado máximo permisible a la entrada	Maximum allowed input ripple	15% Vin nom (EN50155)
SALIDA	OUTPUT	
Tensión de salida	Output voltage	See table
Ajuste de la tensión de salida	Output voltage adjustment	
Vi min = 60% Vi nom	Vi min = 60% Vi nom	-10% ... +0% Vo nom
Vi min = 70% Vi nom	Vi min = 70% Vi nom	-10% ... +15% Vo nom <sup>(1)</sup>
Regulación de línea (Io = nom)	Line regulation (Io = nom)	< 0,2 % (Io = nom)
Regulación de carga (Vin = nom)	Load regulation (Vin = nom)	< 0,2 % (Vin = nom; Io: 0...100%)
Rizado	Ripple	< 50 mVpp
Ruido (BW = 20MHz)	Noise (BW = 20MHz)	< 100 mVpp
AMBIENTE	ENVIRONMENTAL	
Temperatura de almacenamiento	Storage temperature	-40°C ... 85°C
Temperatura de funcionamiento Io: 100%	Operating temperature range Io: 100%	-25°C ... 60°C (-40°C ... 60°C, see note-1)
Temperatura de funcionamiento Io: 75%	Operating temperature range Io: 75%	-25°C ... 70°C (-40°C ... 70°C, see note-1)
Temperatura de funcionamiento Io: 37.5%	Operating temperature range Io: 37.5%	-25°C ... 85°C (-40°C ... 85°C, see note-1)
Humedad relativa máxima	Maximum Relative humidity	95% with no condensation
Choque y vibración	Shock and vibration	EN61373 Category 1 class B body mounted
MTBF	MTBF	400.000h @ 40°C according to IEC61709
CEM	EMC	
Emisión	Emission	EN61000-6-3 EN50121-3-2
Inmunidad	Immunity	EN61000-6-2 EN50121-3-2
SEGURIDAD	SAFETY	
Seguridad	Safety	EN60950 EN50155
Rigidez dieléctrica Entrada-Salida	Dielectric strength Input-Output	3000Vac, 4200Vdc 1min.
Rigidez dieléctrica Entrada-Tierra	Dielectric strength Input-GND	1500Vac, 2100Vdc 1min.
Rigidez dieléctrica Salida-Tierra	Dielectric strength Output-GND	1500Vac, 2100Vdc 1min.
Fuego y humo	Fire and smoke	EN45545-2
MECÁNICA	MECHANICAL	
Peso aproximado	Approximate weight	640g
Dimensiones	Dimensions	100 x 220 x 38.5mm
CONTROL	CONTROL	
Margen de la Inhibición remota	Remote inhibit range	5V ... 24V
Detección remota (opción)	Remote sense (option)	< 0.3V per pole
Alarma de salida baja (Opción)	Low output voltage alarm (option)	Threshold: 0.85...0.90 Vo nom. Open when alarm Isolated solid state relay: max.100mA, 160V
PROTECCIONES	PROTECTIONS	
Contra sobrecargas y cortocircuitos	Against overloads and short-circuits	Current limiting
Contra inversión de polaridad.	Against reverse input voltage.	Input fuse
Contra Sub-tensión de entrada.	Against input under-voltage.	Under-voltage lock-out
Contra Sobre-corrientes de entrada	Against Input over-currents	Input fuse

Note-1: The unit can start up and work at an ambient temperature of -40°C with the following restrictions:

- 1) Do not actuate over the connectors below -25°C.
- 2) The output ripple can rise up to 150mVpp at -40°C

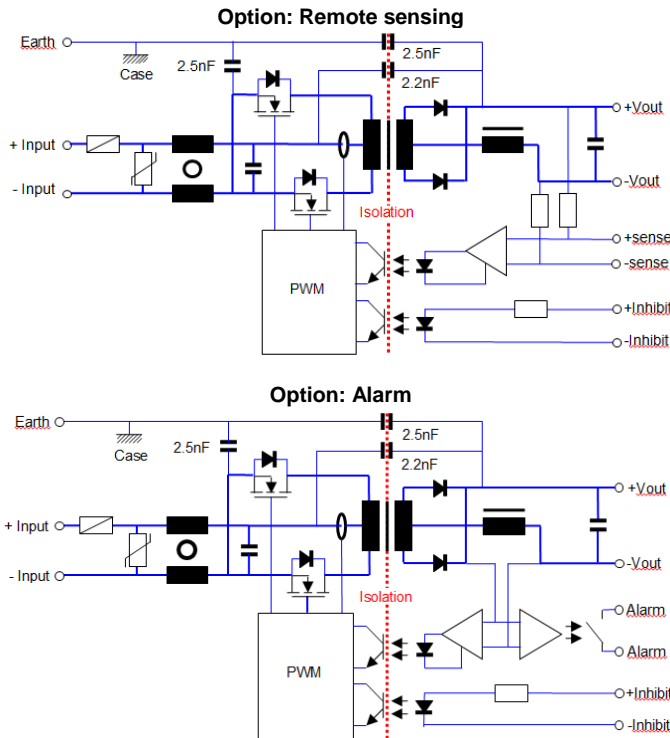

Pinout option: R. sensing	
+Input	8,10
-Input	4,6, (2)
Earth	16
+Output	26,28,30
-Output	20,22,24
+Sense	32
-Sense	18
+Inhibit	14
-Inhibit	12

Pin out option: Alarm	
+Input	8,10
-Input	4,6, (2)
Earth	16
+Output	28,30,32
-Output	22,24,26
Alarm	20
Alarm	18
+Inhibit	14
-Inhibit	12

### DESCRIPCIÓN

La serie CTS-240 está constituida por convertidores de corriente continua a corriente continua con aislamiento galvánico entre la entrada y la salida, conmutando a frecuencia fija y empleando la topología de convertidor en contrafase.

Hay dos opciones a elegir:

- 1 - Con detección remota
- 2 - Con alarma de tensión de salida baja

Para disponer de la máxima regulación, pueden conectarse a la carga los terminales de detección remota. Esto permite compensar una caída en los cables de potencia hasta 0,3V en cada uno de ellos.

El aparato está protegido contra sobrecargas y cortocircuitos por un circuito limitador de corriente.

También está preparado para soportar una inversión de polaridad de tensión a la entrada, fundiendo el fusible de entrada en caso de conexión errónea.

En caso de subtensión en la entrada el convertidor se inhibe evitando la descarga total de la batería.

### DESCRIPTION

The CTS-240 series consists of PWM DC-DC converters, with a galvanic isolation between input and output. The converters operate at a fixed switching frequency and use push-pull converter topology.

There are two options to choose:

- 1 - With remote sensing
- 2 - With low output voltage alarm

For maximum regulation, the remote sensing terminals can be connected to the load. This will allow a power cable voltage drop of up to 0.3 V on each cable to be offset.

The device is protected against overload and short-circuits by means of a current limiting circuit.

The device is also protected against reverse polarity input voltage, and the input fuse blows if an improper connection is made.

When a converter input undervoltage condition occurs, the converter is disabled, thus preventing the battery from becoming totally discharged.

CONECTOR / CONNECTOR DIN 41612 H15 - Max. 12A / Terminal

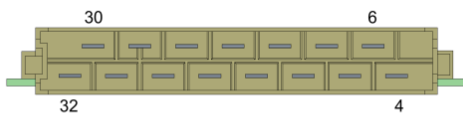

REGLETA DE FASTON / FASTON 1/4" - Max. 18A / Terminal

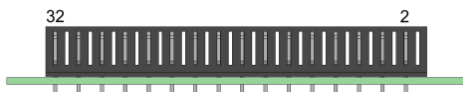

TERMINAL DE CLIP / CLIP TERMINAL - Max. 12A / Terminal

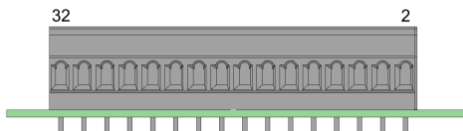

### INSTALACIÓN

Existen tres opciones de conexionado: conector DIN-41612-H15, regleta de FASTON y Regleta de terminales CLIP

El producto pueden instalarse de varias formas:

- Sobre un chasis mediante los 4 taladros de las esquinas
- En portacartas EUROCARD. Pare ello existe un accesorio con la referencia **NP-9155** que es frontal estándar de 9Te.
- Con la base referencia **NP-9125**. Ésta puede montarse sobre un chasis o en carril DIN añadiendo el accesorio clip **NP-9135**.

### INSTALLATION

There are three connecting options: DIN-41612-H15 connector, FASTON block and spring clamp terminal strip.

The product can be mounted in several ways:

- On a chassis by means of the 4 corner holes.
- In EUROCARD racks. For this application there is a standard 9Te front plate accessory reference **NP-9155**
- With the base reference **NP-9125**. This accessory can be mounted on a chassis or in DIN rail adding the clip accessory **NP-9135**.

Typical output characteristic

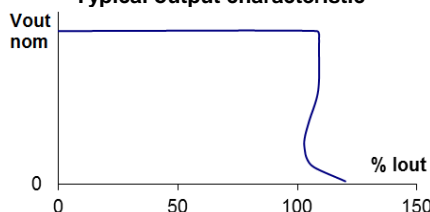

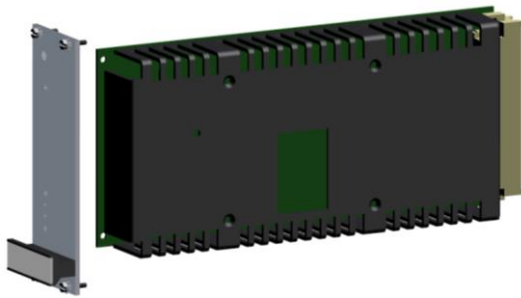
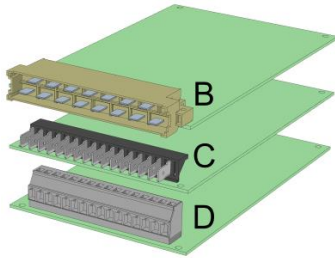
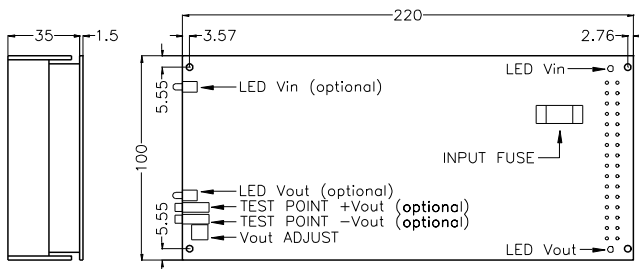

NP-9155

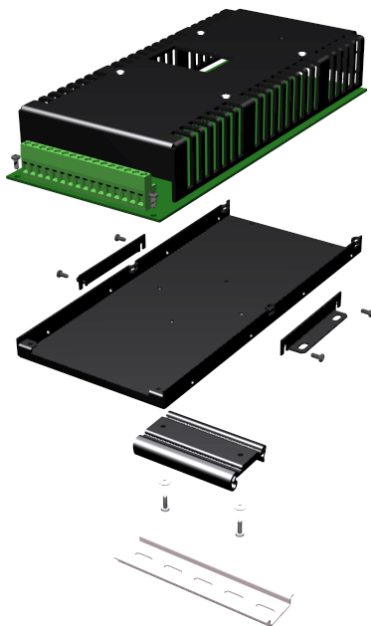

NP-9125

NP-9135

**PUESTA EN MARCHA**

Efectuar la conexión según la tabla. La utilización de la detección remota (sense) no es imprescindible, pero si se requiere hacerla es recomendable utilizar cable coaxial o bien un par trenzado.

**PRECAUCIÓN:** Si la carga se conecta a las tomas de detección remota (+/-S) faltando la conexión de la salida a dicha carga la función detección remota se puede inutilizar debido a la actuación del fusible interno de protección.

Si se requiere obtener potencias cercanas a la máxima es importante que el montaje favorezca la refrigeración por convención natural y la placa esté en posición vertical.

**Si se desea conectar varios convertidores en paralelo deberá realizar lo siguiente:**

- Ajustar la tensión de salida de todos los convertidores con una diferencia entre ellas lo menor posible..
- Unir las salidas en la carga utilizando cables de sección no mayor que la apropiada, y de igual longitud.
- No utilizar detección remota.

**Por motivos de seguridad es necesario:**

- Proporcionar al equipo una envolvente de protección conforme a las directivas de seguridad eléctrica del país donde sea instalado.
- Para sustituir el fusible hacerlo por otro del mismo calibre y tipo con el convertidor desconectado de la alimentación eléctrica.

**START-UP**

Perform connection as per the table. Use of remote sensing is not absolutely necessary, but if this is required, use of a co-axial or a twisted-pair cable is recommended.

**WARNING: If the load is connected to the tabs of remote sensing (+/-S) and the connection from the output to this load is missing the remote sensing function could make unusable due to the acting of the internal fuse of protection.**

If power levels close to the maximum output are required, make sure the assembly enhances cooling by natural convection and the card is placed in vertical position.

**If several converters need to be connected in parallel, do the following:**

Set the output voltage for all converters featuring a mutual difference as small as possible.

Join the load outputs by using cables with a cross-section no greater than the one required and of equal length.

Do not use remote sensing.

**For safety reasons, the following requirements must be complied with:**

Provide the equipment with some kind of protective enclosure that complies with the electrical safety directives in effect within the country where the equipment is installed.

Only replace the fuse with another fuse of the same rating and type, and only after disconnecting the converter from DC power.

**CÓDIGOS DE PEDIDO / ORDERING CODES**

Options	Remote sensing	Alarm
DIN41612H15	CTS-240-66XX-B	CTS-240-66XX-HB
Faston	CTS-240-66XX-C	CTS-240-66XX-HC
Spring clamp terminals	CTS-240-66XX-D	CTS-240-66XX-HD

Accessories	Ordering code
Rack 19" frontal panel (3u 9te)	NP-9155
Mounting base	NP-9125
Din rail clip	NP-9135
Redundant connection	ACD-15, ACD-25



DECLARACIÓN DE CONFORMIDAD UE



EU DECLARATION OF CONFORMITY

El abajo firmante, en representación de /The undersigned, representing the following:  
Fabricante / Manufacturer: PREMIUM, S. A.,  
Dirección / Address: C/. Dolors Aleu 19-21, 2º 2ª 08908L'Hospitalet de Llobregat, SPAIN

declara que el producto / herewith declares that the product:  
Tipo / Type: Convertidor CC/CC / DC/DC converter  
Modelos / Models: **CTS-240-6655...6675**

es conforme con las disposiciones de las siguientes directivas UE:  
is in conformity with the provisions of the following EU directive(s):

2014/35/EU	Baja tensión	Low voltage
2014/30/EU	Compatibilidad electromagnética	Electromagnetic compatibility

y se han aplicado las normas y/o especificaciones técnicas siguientes:  
and that standards and/or technical specifications referenced overleaf have been applied:

EN 60950: 2005	Seguridad (Equipos de tratamiento de la información)	Safety (Information technology equipment)
EN 61000-6-3: 2007	Norma genérica de emisión	Generic emission standard
EN 61000-6-2: 2005	Norma genérica de inmunidad	Generic Immunity standard
EN 50155: 2007*	Aplicaciones ferroviarias. Equipos electrónicos utilizados sobre material rodante	Railway applications. Electronic equipment used on rolling stock material
EN 50121-3-2: 2015*	Aplicaciones ferroviarias. CEM de material rodante. Aparatos	Railway applications. EMC Rolling stock equipment
EN 50121-4: 2015*	Aplicaciones ferroviarias. CEM Aparatos de señalización y telecomunicación	Railway applications. EMC of the signalling and telecommunications apparatus

\* Ver anexo / See annexe

Año del mercado CE / CE marking year: **2006**

Notas / Notes:

Para el cumplimiento de esta declaración el producto debe usarse sólo para el fin que ha sido concebido, teniendo en cuenta las limitaciones establecidas en el manual de instrucciones o la ficha técnica

For the fulfillment of this declaration the product must be used only for the aim that has been conceived, considering the limitations established in the instructions manual or datasheet.

L'Hospitalet de Llobregat, 09-05-2016

Jordi Gazo

Director Gerente / Managing Director

**PREMIUM S.A.** is an ISO9001certified company by **Bureau Veritas**

Valores aplicables para los apartados de la norma EN50155: 2007 Applicable values for the different sections of the norm EN50155: 2007																																																																													
4.1.1	Altitud de trabajo Working altitude	Up to 1800m																																																																											
4.1.2	Temperatura ambiente Ambient temperature	Class T1 column 2: load at 100% Class T2 column 2: load at 100% and output ripple <150mVpp Class T3 column 2: load at 75% Class TX column 2: load at 75% and output ripple <150mVpp																																																																											
4.1.3	Choques y vibraciones Shocks and vibrations	According EN61373:2010 Category 1 class B																																																																											
4.1.4	Humedad relativa Relative humidity	Up to 95%																																																																											
5.1.1.1	Variaciones de la tensión de alimentación Powersupplyvoltagevariations	From 0.70 to 1.25 Un continuous From 0.60 to 1.40 Un 0.1s From 1.25 to 1.40 Un 1s without damage																																																																											
5.1.1.2	Interrupciones de la tensión de alimentación Powersupplyinterruptions	Class S1 (without interruptions)																																																																											
5.1.1.4	Factor de ondulación a la entrada Input ripple factor	Up to 15% of Vin nom																																																																											
5.1.3	Conmutación de la alimentación Powersupplyswitching	Class C1 (0.6 Un during 100ms without interruptions)																																																																											
5.2	Sobretensiones de alimentación Powersupplyover-voltages	1.40 Un 1s (impedance 1 ohm)																																																																											
5.5	CEM Compatibilidad electromagnética EMC ElectromagneticCompatibility  EN50121-3-2:2015  EN50121-4:2015	<table border="1"> <thead> <tr> <th>Test</th> <th>Norm</th> <th>Port</th> <th>Frequency</th> <th>Limits</th> </tr> </thead> <tbody> <tr> <td rowspan="4">Radiated emissions</td> <td rowspan="4">IEC55016</td> <td rowspan="4">Enclosure</td> <td>30MHz...230MHz</td> <td>40dB(µV/m) Qpk at 10m</td> </tr> <tr> <td>230MHz...1GHz</td> <td>47dB(µV/m) Qpk at 10m</td> </tr> <tr> <td>1...3GHz</td> <td>Do not apply</td> </tr> <tr> <td>3...6GHz</td> <td>Internal freq. &lt; 108MHz</td> </tr> <tr> <td rowspan="2">Conducted emissions</td> <td rowspan="2">IEC55016</td> <td rowspan="2">Input</td> <td>150kHz...500kHz</td> <td>99dB(µV) Qpk</td> </tr> <tr> <td>500kHz...30MHz</td> <td>93dB(µV) Qpk</td> </tr> </tbody> </table>	Test	Norm	Port	Frequency	Limits	Radiated emissions	IEC55016	Enclosure	30MHz...230MHz	40dB(µV/m) Qpk at 10m	230MHz...1GHz	47dB(µV/m) Qpk at 10m	1...3GHz	Do not apply	3...6GHz	Internal freq. < 108MHz	Conducted emissions	IEC55016	Input	150kHz...500kHz	99dB(µV) Qpk	500kHz...30MHz	93dB(µV) Qpk																																																				
		Test	Norm	Port	Frequency	Limits																																																																							
		Radiated emissions	IEC55016	Enclosure	30MHz...230MHz	40dB(µV/m) Qpk at 10m																																																																							
					230MHz...1GHz	47dB(µV/m) Qpk at 10m																																																																							
					1...3GHz	Do not apply																																																																							
					3...6GHz	Internal freq. < 108MHz																																																																							
		Conducted emissions	IEC55016	Input	150kHz...500kHz	99dB(µV) Qpk																																																																							
					500kHz...30MHz	93dB(µV) Qpk																																																																							
		<table border="1"> <thead> <tr> <th>Test</th> <th>Norm</th> <th>Port</th> <th>Severity</th> <th>Conditions</th> <th>P</th> </tr> </thead> <tbody> <tr> <td rowspan="2">Electrostatic discharge</td> <td rowspan="2">IEC61000-4-2</td> <td rowspan="2">Case</td> <td>±8kV</td> <td>Air (isolated parts)</td> <td rowspan="2">B</td> </tr> <tr> <td>±8kV</td> <td>Contact (conductive parts)</td> </tr> <tr> <td rowspan="3">Radiated high-frequency</td> <td rowspan="3">IEC61000-4-3</td> <td rowspan="3">X/Y/Z Axis</td> <td>20V/m</td> <td>0.08...1.0GHz M. 80% 1kHz</td> <td rowspan="3">A</td> </tr> <tr> <td>10V/m</td> <td>1.4...2.1GHz M. 80% 1kHz</td> </tr> <tr> <td>5V/m</td> <td>2.1...2.5GHz M. 80% 1kHz</td> </tr> <tr> <td rowspan="4">Fast transients</td> <td rowspan="4">IEC61000-4-4</td> <td rowspan="4">Input</td> <td>±2kV</td> <td>Tr/Th: 5/50 ns</td> <td rowspan="4">A</td> </tr> <tr> <td>Output</td> <td>±2kV</td> <td>Tr/Th: 5/50 ns</td> </tr> <tr> <td>Signal</td> <td>±2kV</td> <td>Tr/Th: 5/50 ns</td> </tr> <tr> <td>E</td> <td>±1kV</td> <td>Tr/Th: 5/50 ns</td> </tr> <tr> <td rowspan="2">Surge</td> <td rowspan="2">IEC61000-4-5</td> <td rowspan="2">Input L to L</td> <td>±1kV</td> <td>Tr/Th: 1.2/50µs</td> <td rowspan="2">B</td> </tr> <tr> <td>Input L to E</td> <td>±2kV</td> <td>Tr/Th: 1.2/50µs</td> </tr> <tr> <td rowspan="4">Conducted RF</td> <td rowspan="4">IEC61000-4-6</td> <td rowspan="4">Input</td> <td>10V</td> <td>0.15...80MHz M. 80% 1kHz</td> <td rowspan="4">A</td> </tr> <tr> <td>Output</td> <td>10V</td> <td>0.15...80MHz M. 80% 1kHz</td> </tr> <tr> <td>Signal</td> <td>10V</td> <td>0.15...80MHz M. 80% 1kHz</td> </tr> <tr> <td>E</td> <td>10V</td> <td>0.15...80MHz M. 80% 1kHz</td> </tr> <tr> <td>Magnetic field</td> <td>IEC61000-4-8</td> <td>X/Y/Z Axis</td> <td>300A/m</td> <td>0Hz, 16.7Hz, 50/60Hz</td> <td>A</td> </tr> <tr> <td>Pulse magnetic field</td> <td>IEC61000-4-9</td> <td>X/Y/Z Axis</td> <td>300A/m</td> <td>Tr/Th: 6.4/16µs</td> <td>B</td> </tr> </tbody> </table>	Test	Norm	Port	Severity	Conditions	P	Electrostatic discharge	IEC61000-4-2	Case	±8kV	Air (isolated parts)	B	±8kV	Contact (conductive parts)	Radiated high-frequency	IEC61000-4-3	X/Y/Z Axis	20V/m	0.08...1.0GHz M. 80% 1kHz	A	10V/m	1.4...2.1GHz M. 80% 1kHz	5V/m	2.1...2.5GHz M. 80% 1kHz	Fast transients	IEC61000-4-4	Input	±2kV	Tr/Th: 5/50 ns	A	Output	±2kV	Tr/Th: 5/50 ns	Signal	±2kV	Tr/Th: 5/50 ns	E	±1kV	Tr/Th: 5/50 ns	Surge	IEC61000-4-5	Input L to L	±1kV	Tr/Th: 1.2/50µs	B	Input L to E	±2kV	Tr/Th: 1.2/50µs	Conducted RF	IEC61000-4-6	Input	10V	0.15...80MHz M. 80% 1kHz	A	Output	10V	0.15...80MHz M. 80% 1kHz	Signal	10V	0.15...80MHz M. 80% 1kHz	E	10V	0.15...80MHz M. 80% 1kHz	Magnetic field	IEC61000-4-8	X/Y/Z Axis	300A/m	0Hz, 16.7Hz, 50/60Hz	A	Pulse magnetic field	IEC61000-4-9	X/Y/Z Axis	300A/m	Tr/Th: 6.4/16µs	B
		Test	Norm	Port	Severity	Conditions	P																																																																						
		Electrostatic discharge	IEC61000-4-2	Case	±8kV	Air (isolated parts)	B																																																																						
					±8kV	Contact (conductive parts)																																																																							
		Radiated high-frequency	IEC61000-4-3	X/Y/Z Axis	20V/m	0.08...1.0GHz M. 80% 1kHz	A																																																																						
					10V/m	1.4...2.1GHz M. 80% 1kHz																																																																							
					5V/m	2.1...2.5GHz M. 80% 1kHz																																																																							
Fast transients	IEC61000-4-4	Input	±2kV	Tr/Th: 5/50 ns	A																																																																								
			Output	±2kV		Tr/Th: 5/50 ns																																																																							
			Signal	±2kV		Tr/Th: 5/50 ns																																																																							
			E	±1kV		Tr/Th: 5/50 ns																																																																							
Surge	IEC61000-4-5	Input L to L	±1kV	Tr/Th: 1.2/50µs	B																																																																								
			Input L to E	±2kV		Tr/Th: 1.2/50µs																																																																							
Conducted RF	IEC61000-4-6	Input	10V	0.15...80MHz M. 80% 1kHz	A																																																																								
			Output	10V		0.15...80MHz M. 80% 1kHz																																																																							
			Signal	10V		0.15...80MHz M. 80% 1kHz																																																																							
			E	10V		0.15...80MHz M. 80% 1kHz																																																																							
Magnetic field	IEC61000-4-8	X/Y/Z Axis	300A/m	0Hz, 16.7Hz, 50/60Hz	A																																																																								
Pulse magnetic field	IEC61000-4-9	X/Y/Z Axis	300A/m	Tr/Th: 6.4/16µs	B																																																																								
P= Performance criteria, L= Line, E= PE (Protective Earth)																																																																													
7.2.6	Protección inversión de polaridad de entrada Input reverse polarity protection	By fuse																																																																											
9.7	Recubrimiento de protección del PCB PCB protection	PCB conformal coated																																																																											
12.2	Lista de ensayos Tests list	<table border="0"> <tr> <td>1 Visual Inspection</td> <td>Routine</td> </tr> <tr> <td>2 Performance test</td> <td>Routine</td> </tr> <tr> <td>3 Cooling</td> <td>Type</td> </tr> <tr> <td>4 Dry heat</td> <td>Type</td> </tr> <tr> <td>6 Supply overvoltages</td> <td>Type</td> </tr> <tr> <td>7 Surge, ESD and burst susceptibility</td> <td>Type</td> </tr> <tr> <td>8 RF Interferences</td> <td>Type</td> </tr> <tr> <td>9 Insulation</td> <td>Routine</td> </tr> <tr> <td>11 Shocks and vibrations</td> <td>Type</td> </tr> <tr> <td>13 Equipment stress screening: 24h at 40°C and load 100%</td> <td>Routine</td> </tr> <tr> <td>14 Low temperature storage</td> <td>Type</td> </tr> </table>	1 Visual Inspection	Routine	2 Performance test	Routine	3 Cooling	Type	4 Dry heat	Type	6 Supply overvoltages	Type	7 Surge, ESD and burst susceptibility	Type	8 RF Interferences	Type	9 Insulation	Routine	11 Shocks and vibrations	Type	13 Equipment stress screening: 24h at 40°C and load 100%	Routine	14 Low temperature storage	Type																																																					
1 Visual Inspection	Routine																																																																												
2 Performance test	Routine																																																																												
3 Cooling	Type																																																																												
4 Dry heat	Type																																																																												
6 Supply overvoltages	Type																																																																												
7 Surge, ESD and burst susceptibility	Type																																																																												
8 RF Interferences	Type																																																																												
9 Insulation	Routine																																																																												
11 Shocks and vibrations	Type																																																																												
13 Equipment stress screening: 24h at 40°C and load 100%	Routine																																																																												
14 Low temperature storage	Type																																																																												